



thintanks

# PRODUCT SPECIFICATION

## **1000L New** **(Series 2021)**

Manufactured: QLD & NSW

The Latest Innovation In Rainwater Tank

P : + 61 (8) 490 6941

E: [info@thintanks.com.au](mailto:info@thintanks.com.au)

W: [www.thintanks.com.au](http://www.thintanks.com.au)



thintanks

We create rainwater tanks that fit anywhere.

Designed for easy installation & space saving, ThinTanks™ Slimline Rainwater Tanks are the thinnest available water tank for any capacity. On the forefront of ground-breaking technology, the Adelaide-made ThinTanks™ range of rainwater storage tanks has been developed for space-saving water conservation across both residential and commercial applications.

1000L New Series 2021

# THINTANKS

Length 2,400mm x Height 1,970mm x Width 260mm x Weight 95kg

Manufactured in QLD and NSW

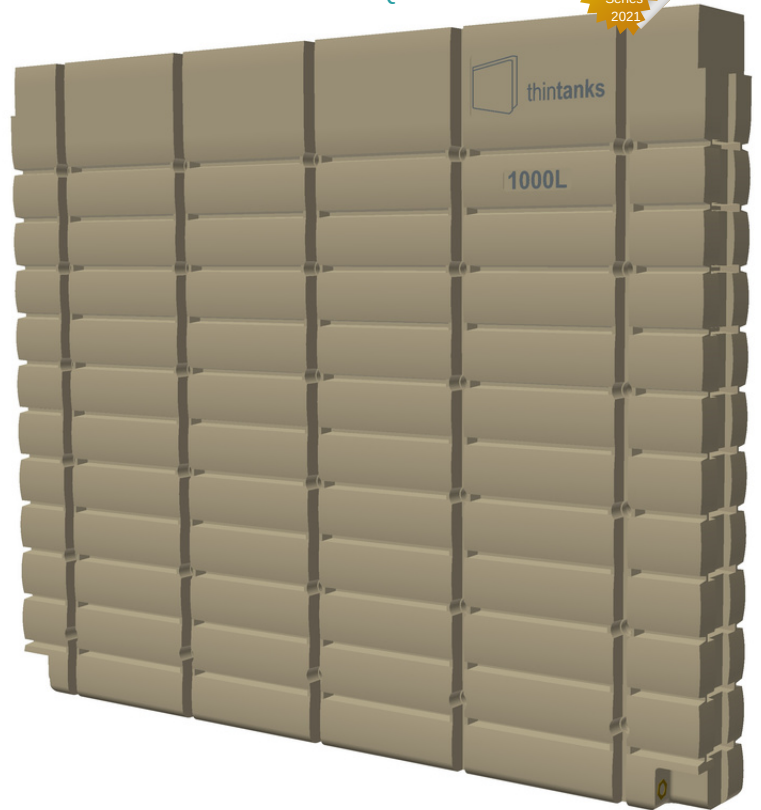

The 1000 Litre Thintank is only 260mm wide! It's the Thinnest Poly Tank on the market and with its fence like appearance it's the perfect tank for those smaller yards where space is limited. They can be fixed to a wall on the side of a dwelling or freestanding with the post rebate and act as a fence!



## CONSERVE WATER WITH A STYLE



Choose from 12 different colours Colorbond colours



DISCLAIMER  
Actual colours may vary. We try extremely hard to ensure our photos are as life-like as possible, but please understand the actual colour may vary slightly from your monitor. We cannot guarantee that the colour you see accurately portrays the true colour of the product.

Supplied with standard tank fittings

-  25mm Brass Outlet
-  200mm Inlet Strainer
-  90mm Overflow Fittings
-  25mm Ball Valve

Contact Us

## 1000L New

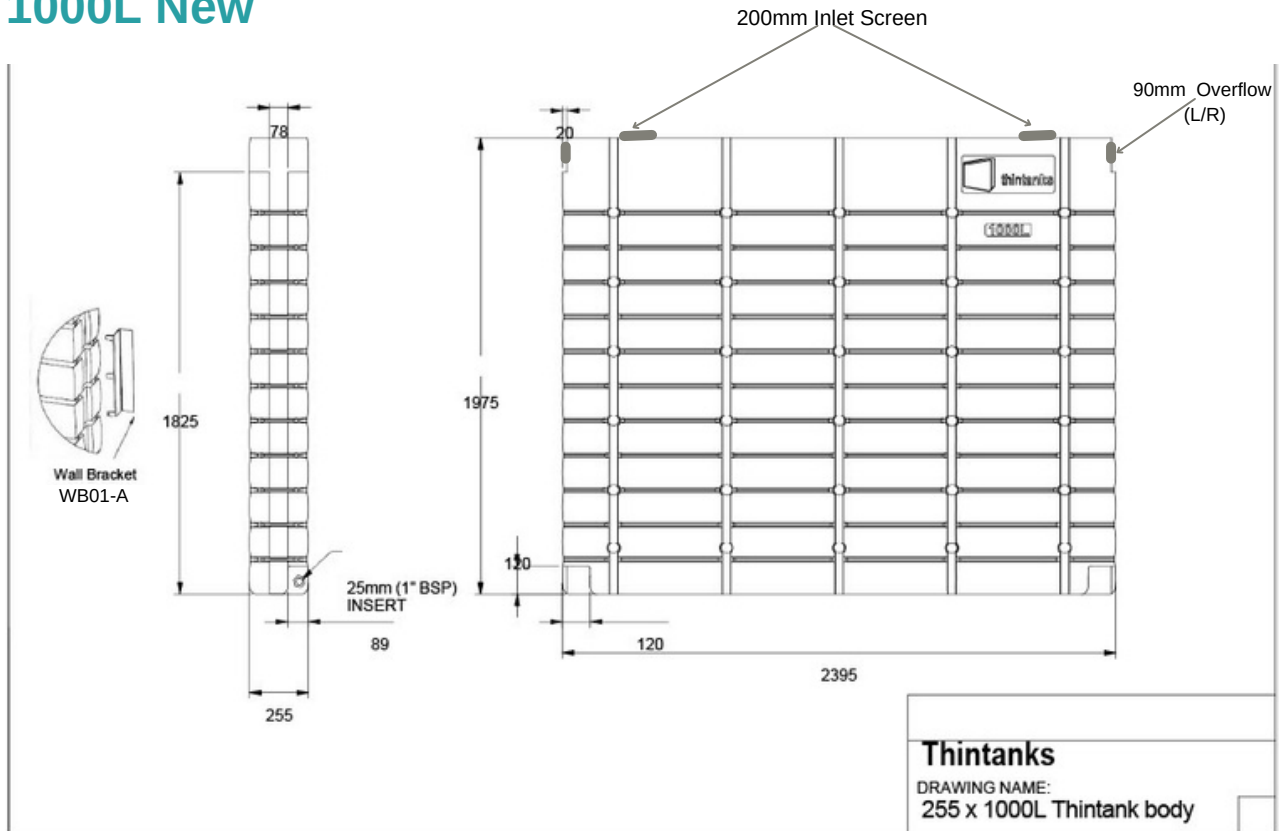

## Product Suitability

The product recommendations used in this brochure are intended only as a guide. While we make every effort to accurately represent the suitability of our products for a variety of uses, every situation may be unique and require additional investigation when necessary. Thintanks holds the right to change equipment and product accessories in line with ongoing developments and product supply.

## Product Specifications

Due to the variable shrinkage rate of polyethylene, the product dimensions and capacities listed here are approximate. Naturally occurring pigment variations in raw materials may also cause some variability in colour shades. While we are trying to come as close to the advertised shades as possible, we are unable to guarantee exact tank colour matches. Due to ongoing improvement and innovation, product details, design and specifications are subject to change without notice.

# 1000L- New Thintanks Installation

## THINTANK INSTALLATION.

It is important for tanks to stand on a solid base, that will not settle or move when wet. The tanks(s) can be laid on sloping ground, along the length of the tank. The surface must be horizontal across the width of the tank to allow the sides of the tank to be vertical.

### Freestanding

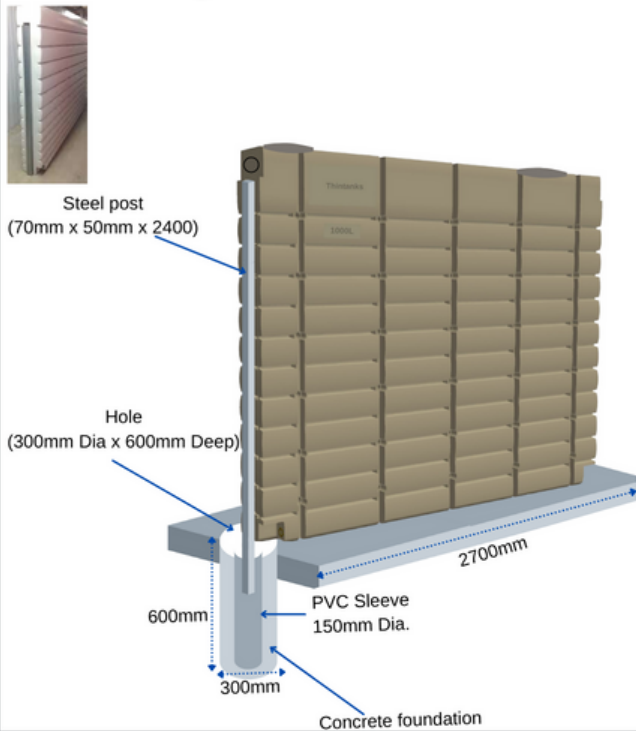

### Against the wall

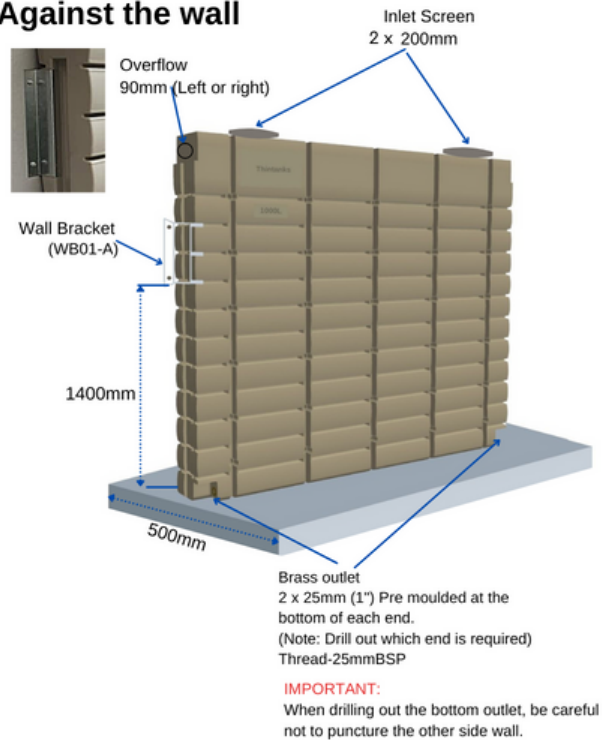

### 1000 Litre - Freestanding

- Mark the position of support poles and excavate holes for 70mm x 50mm x 2400 long posts.
- Holes to be 300mm in diameter and 600mm deep.  
*Caution: This size may not be large enough in sandy areas. Seek advice from a local fencing contractor or a civil engineer*
- Lay concrete slab/pavers between holes.
- Position 150mm PVC sleeves and concrete around outside of sleeves and up to slab/paver.
- After the concrete has been set, slide the tank into position up against the vertical post. When correctly positioned, the tank should sit flush with the post and be held in place by the end recess.
- Install the second post on the opposite side as per step 1
- Concrete around posts to finish off

### 1000 Litre - Wall Mounted

- On an existing pavement, sloping away from a fence or wall, the surface must be built up to ensure the tank face is vertical and the back of the tank is flush against the fence or wall. See diagram.
- Position the first tank on the prepared base and fix to fence or wall using bracket WB01-A (picture above) on each end. Wall bracket needs to be fixed to the wall using Dyna Bolts on both ends of the brackets
- Place brackets approximately 1400mm above the base. See diagram.

Brackets are required to ensure tank(s) cannot be accidentally pulled over by human effort.

### Multiple Tanks Freestanding

Continue the following steps when installing multiple tanks



- Attach blue line coupling to each tank. Insert blue line to installed tank and wrench tighten to secure.



- Slide tank into position easing the pipe into the second tank coupling. Once full seated, the tanks will sit almost flush and fitting can be wrench tightened to secure.



- Install final post and concrete in position as per step 1 to finish the installation

Note: For multiple tanks, inlet and overflow must still be connected to the same tank.

### Fittings



- Install the downpipe into the inlet pre-fitted with leaf strainer. Either end can be used.



- Install overflow pipework and plumb away from tank base.

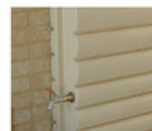

- Install bucket height tap(if required)

**Warranty** Thin Tanks warrants its tanks by a pro-rata warranty for 10 years from the original date of purchase. This warranty covers the original purchaser only and is not transferable. Thin Tanks will repair or replace, at their discretion the tank affected by a defect caused by the manufacturing process or materials. Fading or colour change, damage caused by accidents or misuse, do-it yourself repairs or incorrect installation, and any subsequent costs (including freight of replacement tank) are not covered by warranty.

# THINPOTS New - Series 2

ThinPots are specially designed to hang on the front of your ThinTank to create a unique Vertical Garden System. The ThinPots clip directly onto an irrigation pipe, which gives an option to be watered direct from the tank or just simply hand water; each ThinPot features handy drainage holes. The options are endless when it comes to turning your tank into a garden! The Thinpots New Series fits in all Thintanks NEW SERIES tanks, including our Fat Series. (1000L, 2000L,3000L,4000L,1333L Fat & 2000L Fat).



Length: 230mm

Height: 200mm

Width: 90mm

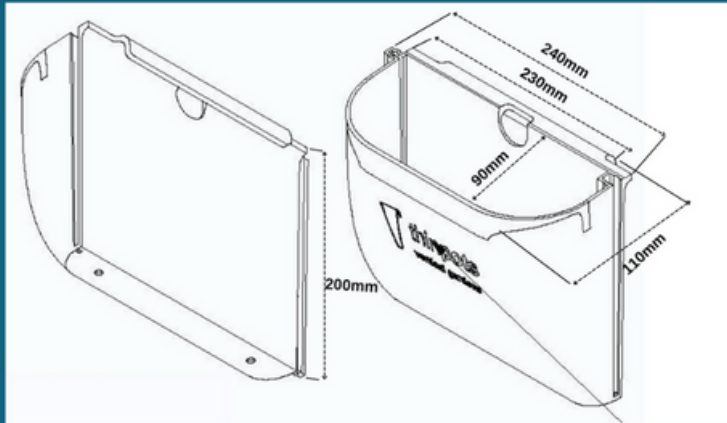

## CREATE A VERTICAL GARDEN !!!

A New 1000L Thintank can take 40 ThinPots to make a full face vertical garden.

1 row	-	8 pots
2 rows	-	16 pots
3 rows	-	24 pots
4 rows	-	32 pots
5 rows	-	40 pots

## 4 Different Colours to choose from:



Surf Mist



Merino



Slate Grey



Monument

### DISCLAIMER

Actual colours may vary. We try extremely hard to ensure our photos are as life-like as possible, but please understand the actual colour may vary slightly from your monitor and everyone can see these colours differently. We cannot guarantee that the colour you see accurately portrays the true colour of the product.



# THINPOTS INSTALLATION GUIDE

## SERIES 2 -NEW DESIGN

This Thinpot Vertical Garden System has been specifically designed to suit the 1333L, 2000L, 2000L Fat and the 4000L Thintanks

### 1. REPLACE THE WALL PLUGS

The Thinpots are hung on the face of the tank by removing the existing wall plugs in the tank and insert the Thinpot adaptor plugs parallel to the horizontal channels in the tank by using a rubber mallet.



### 2. CLIP THE POLY PIPE

Then clip 13mm black poly pipe onto the adaptor plugs. The poly pipe should be cut off 20mm past the last adapter hook each end.



### 3. STOP END, BARB ELBOW, BARBE TEE & RATCHET CLAMP

For a single row of pots a stop end should be fitted with a ratchet clamp at both end of the poly pipe.

For multiple rows a barbed elbow or a barbed tee fitting should be fitted into the poly pipe

All connections should be fitted with a ratchet clamp using multi-grip pliers for either self-irrigation system or manual watering.



### 4. JOINED AND HANG THE THINPOTS

Clip the 2 Thinpots together. The Series 2 Thinpot is designed to be joined in groups of two between the adapter plugs. There is a male/female on the end of every Thinpot. Simply join the pots by sliding the male channel into the female channel. Once the two pots are joined together, hang on to the poly pipe.



FOR HAND WATERING, GO TO STEP 8

### 5. PUNCH HOLES

If you are using an irrigation system then now is the time to punch holes in the poly pipe centrally located in the cut out in the rear of the Thinpots.



### 6. EMITTER

With the holes punched in the poly pipe, hold the pipe firmly in one hand and push the barbed end of the emitter into the hole (often makes a click once inserted)



### 7. PRESSURE REDUCER

If you are using an irrigation system then a pressure reducer must be used unless using a low energy consuming pump.



### 8. FILLING

The Thinpots can now be filled. They must be filled of at least 1/3 with coconut fibre or a similar product and then the rest potting mix (this will stop the potting mix falling out, allow for a free flow of surplus water and also to limit the weight in the pots). Once filled insert chosen your plants

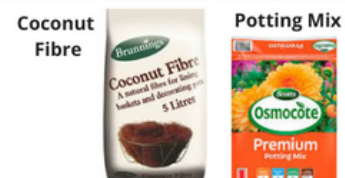

### POINTS TO NOTE

- ALL CONNECTIONS MUST HAVE A RATCHET CLAMP
- THINPOTS MUST BE FILLED A MINIMUM 1/3 OF COCONUT FIBRE (SIMILAR PRODUCT)
- IF USING AN IRRIGATION SYSTEM THEN A PRESSURE REDUCER MUST BE USED

Note:

We supply Thinpots and connectors only.

All others accessories can be purchased from hardware or irrigation suppliers.

For more information, visit us on our website:

[www.thintanks.com.au](http://www.thintanks.com.au)

Follow us:



Now its time to enjoy your Vertical Garden!!!

