

# PRODUCT SPECIFICATION

## 3000L

### Series2

(2021)

Manufactured: ADL

The Latest Innovation In Rainwater Tank

P : + 61 (8) 490 6941

E: [info@thintanks.com.au](mailto:info@thintanks.com.au)

W: [www.thintanks.com.au](http://www.thintanks.com.au)

# 3000L

Length 2980mm x Height 1970mm x Width 580mm x 175kg

The 3000 Litre Thintank caters for those properties with a little more space and where they are needing to catch a bigger amount of water while still looking for a sleek and attractive tank.



## 12 colours to choose:

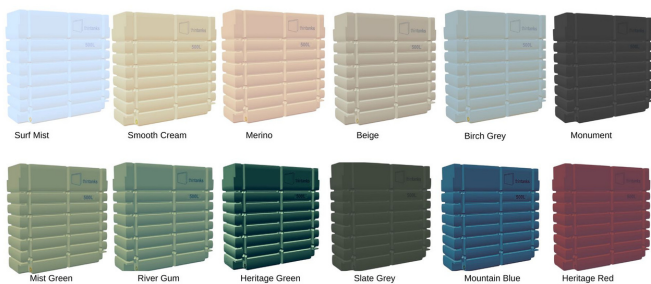

## Fittings (Inclusion)

- 2 x 300mm Inlet Strainer
- 1 x 90mm Overflow fitting
- 2 x 25mm Brass Outlet
- 1 x 25mm Ball Valve

## Brackets

- WB01-A - Wall bracket
- BS201 - Floor bracket
- BSD02 - Joiner Bracket



## Product Specifications

Due to the variable shrinkage rate of polyethylene, the product dimensions and capacities listed here are approximate. Naturally occurring pigment variations in raw materials may also cause some variability in colour shades. While we are trying to come as close to the advertised shades as possible, we are unable to guarantee exact tank colour matches. Due to ongoing improvement and innovation, product details, design and specifications are subject to change without notice.

## Product Suitability

The product recommendations used in this brochure are intended only as a guide. While we make every effort to accurately represent the suitability of our products for a variety of uses, every situation may be unique and require additional investigation when necessary. Thintanks holds the right to change equipment and product accessories in line with ongoing developments and product supply.

# 3000L Thintank

Capacity	Length	Width	Height	Weight
3000Litre	2980mm	580mm	1970mm	175kg

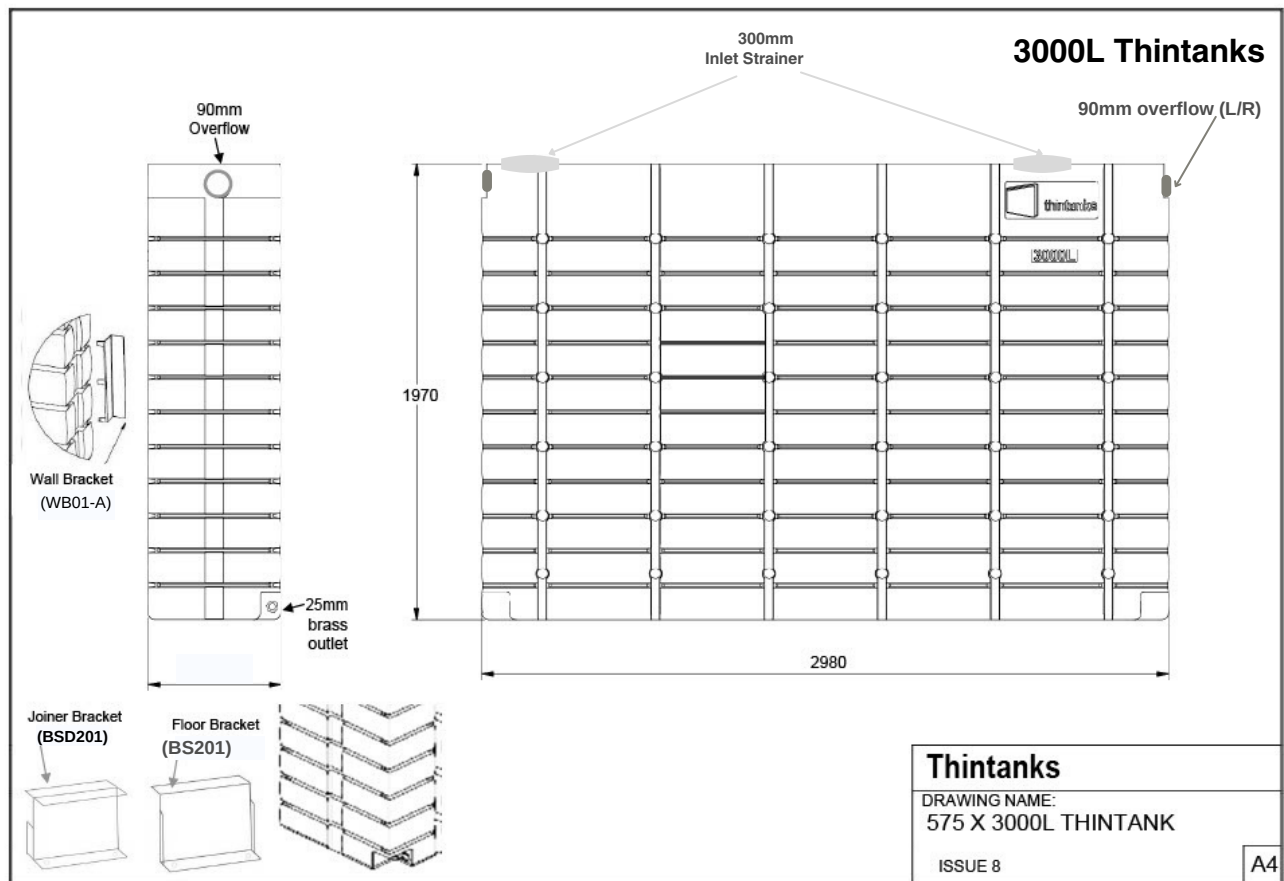
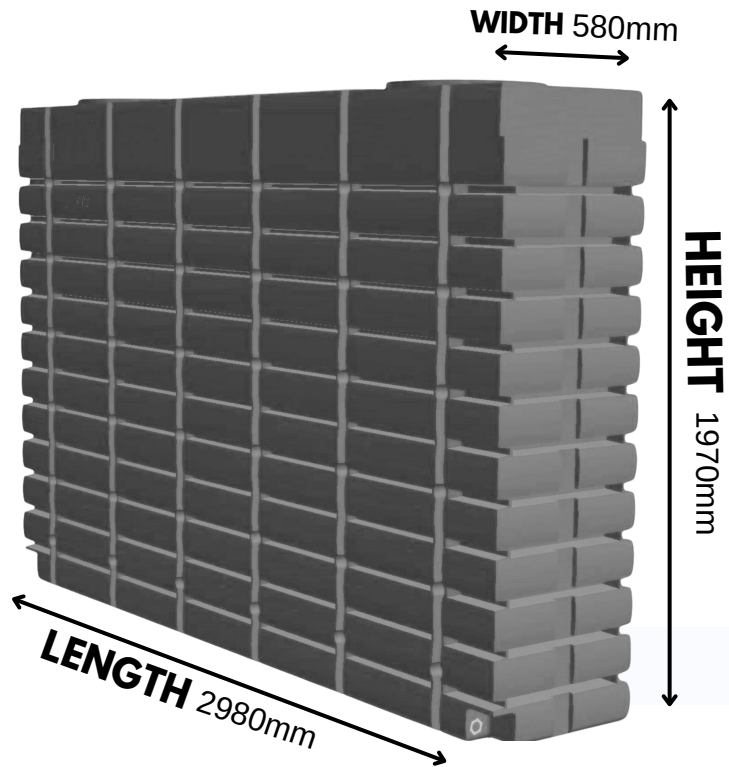

# 3000L S2 Installation

## THINTANK INSTALLATION

It is important for tanks to be installed on a SOLID AND COMPLETELY LEVEL SURFACE. Brackets are recommended to ensure tank(s) cannot be accidentally pulled over by human effort.

### 3000L-Against the wall

(2980mm x 580mm x 1970mm)

- On an existing pavement, sloping away from the wall, the surface must be built up to ensure the tank face is vertical and the back of the tank is flush against the wall.
- Position the tank on the prepared base and fix it to the wall using bracket WB01-A on each end.
- Place brackets approximately 1400mm above the base. Wall brackets need to be fixed to a wall using Dyna Bolts on both ends of the brackets.

\*Brackets are recommended to ensure the tank cannot be accidentally pulled over.

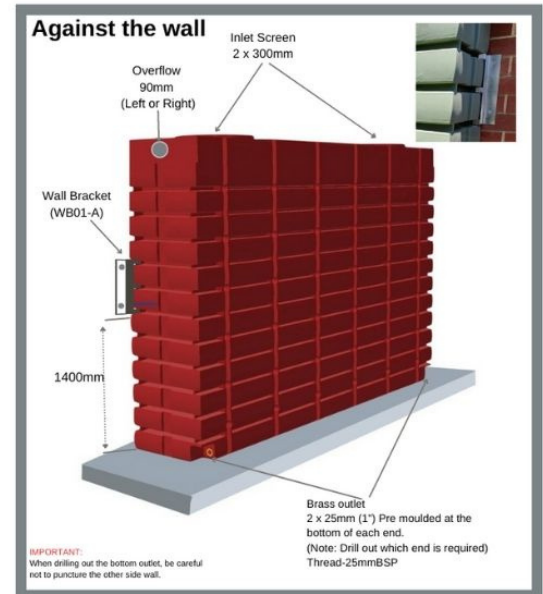

### 3000L-Freestanding

(2980mm x 580mm x 1970mm)

- Form and pour a 100mm thick concrete slab, 800mm wide with 100mm overlap on ends.
- Use F82 fabric placed centrally 75mm above the prepared surface.
- Use a carpenter's level to make sure the concrete surface is level across the width.
- Secure the tank to the concrete using brackets BS201 - one at each end.

#### Multiple Tanks - Freestanding.

Continue the following steps when installing multiple tanks

\* With multiple tanks use bracket BSD201 and Tank to Tank connection kit between tanks

- Attach blue line coupling to each tank. Insert blue line to installed tank and wrench tighten to secure.
- Place the joiner bracket (BSD201) on the other end of the first tank and secure it to the ground using Dyna bolts.
- Slide the second tank into position easing the pipe into the second tank coupling.
- Once fully seated, the tanks will sit almost flush and the fitting can be wrench-tightened to secure.
- Install the BS201 (end bracket) on the other end of the second tank and finish the installation.

\*Brackets are recommended to ensure the tank cannot be accidentally pulled over.

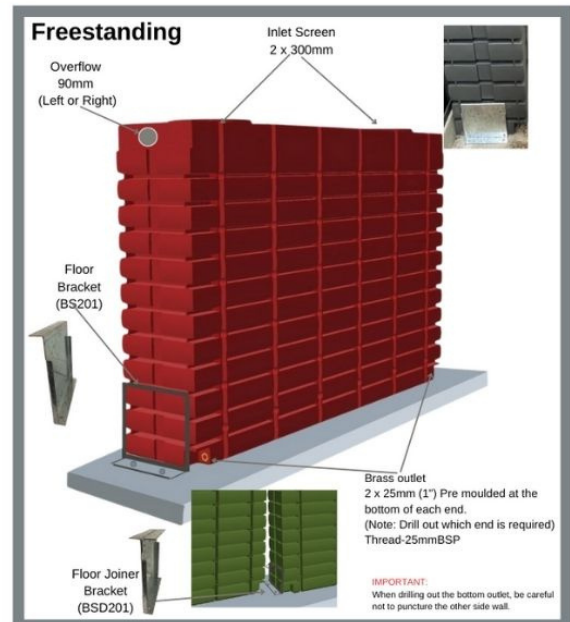

#### Multiple tanks connection fittings



2 tanks connected with tank to tank connection kit

**IMPORTANT:**  
Thread tape should be used on all couplings and ball valves.

#### Brackets



BS201 BSD201

#### Fittings



- Drill out whichever end is required to put the ball valve
  - Install the downpipe into the inlet pre-fitted with leaf strainer.
  - Install overflow pipework and plumb away from tank base or into storm water
  - install bucket height tap (if required)
- Note: For multiple tanks, inlet and overflow must still be connected to the same tank.

**WARRANTY** Thin Tanks warrants its tanks by a pro-rata warranty for 10 years from the original date of purchase. This warranty covers the original purchaser only and is not transferable. Thin Tanks will repair or replace, at their discretion the tank affected by a defect caused by the manufacturing process or materials. Fading or colour change, damage caused by accidents or misuse, do-it yourself repairs or incorrect installation, and any subsequent costs (including freight of replacement tank) are not covered by warranty.

ThinPots are specially designed to hang on the front of your ThinTank to create a unique Vertical Garden System. The ThinPots clip directly onto an irrigation pipe, which gives an option to be watered direct from the tank or just simply hand water; each ThinPot features handy drainage holes. The options are endless when it comes to turning your tank into a garden! The Thinpots New Series fits in all Thintanks NEW SERIES tanks, including our Fat Series. (1000L New, 2000L,3000L,4000L,1333L Fat & 2000L Fat).



Length: 230mm

Height: 200mm

Width: 90mm

CREATE A VERTICAL GARDEN !!!

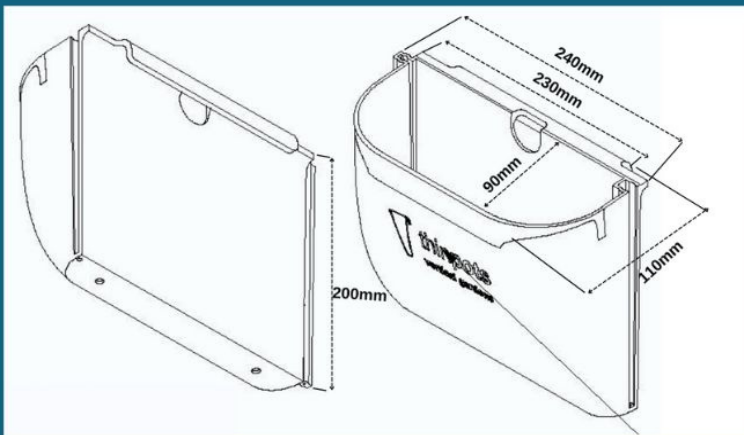

MODEL/SIZE	Max. NO. OF ROWS	Max. NO. OF POTS per ROW	TOTAL NO. OF POTS
500L	3	4	12
1333L	5	2	10
1000L-S2	5	8	40
2000L-S2	5	8	40
2000L Fat	5	4	20
3000L-S2	5	10	50
4000L	5	10	50

4 Different Colours to choose from:



**DISCLAIMER**  
Actual colours may vary. We try extremely hard to ensure our photos are as life-like as possible, but please understand the actual colour may vary slightly from your monitor and everyone can see these colours differently. We cannot guarantee that the colour you see accurately portrays the true colour of the product.



# THINPOTS INSTALLATION GUIDE

## SERIES 2 -NEW DESIGN

This Thinpot Vertical Garden System has been specifically designed to suit the 1333L, 2000L, 2000L Fat, 3000L and the 4000L Thintanks

### 1. REPLACE THE WALL PLUGS

The Thinpots are hung on the face of the tank by removing the existing wall plugs and inserting the Thinpot adaptor plugs parallel to the horizontal channels in the tank by using a rubber mallet.



### 2. CLIP THE POLY PIPE

Then clip 13mm black poly pipe onto the adaptor plugs. The poly pipe should be cut off 20mm past the last adapter hook each end.



### 3. STOP END, BARB ELBOW, BARBE TEE & RATCHET CLAMP

For a single row of pots a stop end should be fitted with a ratchet clamp at both end of the poly pipe.

For multiple rows a barbed elbow or a barbed tee fitting should be fitted into the poly pipe

All connections should be fitted with a ratchet clamp using multi-grip pliers for either self-irrigation system or manual watering.



### 4. JOINED AND HANG THE THINPOTS

Clip the 2 Thinpots together. The Series 2 Thinpot is designed to be joined in groups of two between the adaptor plugs. There is a male/female on the end of every Thinpot. Simply join the pots by sliding the male channel into the female channel. Once the two pots are joined together, hang on to the poly pipe.



**FOR HAND WATERING, GO TO STEP 8**

### 5. PUNCH HOLES

If you are using an irrigation system then now is the time to punch holes in the poly pipe centrally located in the cut out in the rear of the Thinpots.



### 6. EMITTER

With the holes punched in the poly pipe, hold the pipe firmly in one hand and push the barbed end of the emitter into the hole (often makes a click once inserted)



### 7. PRESSURE REDUCER

If you are using an irrigation system then a pressure reducer must be used unless using a low energy consuming pump.

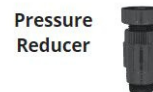

### 8. FILLING

The Thinpots can now be filled. They must be filled of at least 1/3 with coconut fibre or a similar product and then the rest potting mix (this will stop the potting mix falling out, allow for a free flow of surplus water and also to limit the weight in the pots). Once filled insert your chosen plants



#### POINTS TO NOTE

- ALL CONNECTIONS MUST HAVE A RATCHET CLAMP
- THINPOTS MUST BE FILLED WITH A MINIMUM OF 1/3 OF COCONUT FIBRE (SIMILAR PRODUCT)
- IF USING AN IRRIGATION SYSTEM THEN A PRESSURE REDUCER MUST BE USED

Note:

We supply Thinpots and connectors only.

All others accessories can be purchased from hardware or irrigation suppliers.

For more information, visit us on our website:

[www.thintanks.com.au](http://www.thintanks.com.au)

Follow us:



Now its time to enjoy your Vertical Garden!!!

